

OCS-T
High Resolution Digital Crane Scale



User Guide

Content

<u>1. Safety Guide</u>	<u>1</u>
<u>2. Features</u>	<u>1</u>
<u>3. Specifications</u>	<u>2</u>
<u>4. Capacity</u>	<u>3</u>
<u>5. Dimension & Weight</u>	<u>3</u>
<u>6. Display & Keys</u>	<u>4</u>
Scale Keys	4
Remote Keys	4
Indicators	5
Message	5
<u>7. Operations</u>	<u>6</u>
Power On/Off	6
Zero	6
Tare In/Out	6
Lock/unlock	7
Accumulate	7
View	7
Delete Last Weight	7
Clear All Weight	8
Unit Switch	8
<u>8. User Setup</u>	<u>8</u>
Auto-Off Timing	8
Display Brightness	9
Idle Mode Timing	9
<u>9. Battery Maintenance</u>	<u>9</u>
<u>10. Troubleshooting</u>	<u>10</u>
<u>11. Loading Procedures</u>	<u>12</u>

Please read this manual carefully before using. Version: V1.0A-3

1. Safety Guide

For good performance and precise measurement, be careful with daily operation and maintenance.

- ❗ Do NOT overload scale. This will damage loadcell and void warranty.
- ❗ Do NOT leave load hung on the scale for long. This will decrease scale's accuracy and shorten loadcell's life.
- ❗ Inspect shackle and hook before using. Check clips, pins and screws regularly.
- ❗ Check battery frequently. When scale runs out of power, charge battery with its dedicated charger.
- ❗ Rotate load rather than scale if needed.
- ❗ Do NOT use scale under thunder or rain.
- ❗ Hang scale on shelf in dry and well-ventilated room. Do NOT place scale on the ground directly.
- ❗ Do NOT attempt to repair scale yourself. Contact your local representative.

2. Features

This scale is a combination of sound and proven mechanical design, with today's most advanced electronics to provide a superb feature set. It is versatile, reliable, accurate and easy to operate.

- ☑ **Superb Quality.** Strictly in accordance with OIML R76, Chinese GB/T11883-2002 national standards, and European CE directives.
- ☑ **Great Safety.** Aluminum-casting case, high firm hook and

shackle, dedicated weighing loadcell for safety installation.

- ☑ **Strong Reliability.** Cutting-edge technology, quality integrated circuit for high performance and long time stability.
- ☑ **Broad Applicability.** Popular and applicable in storage, textile, metallurgy industry, and so forth.
- ☑ **Easy to Use.** Ultra-red remote controlling design. Easy to operate on the scale or in distance.
- ☑ **Complete Function.** Resolution switch, unit conversion, auto power-off, battery inspection, etc.

3. Specifications

Accuracy Class	Chinese GB/T 11883-2002 Class III Equivalent to OIML R76
Tare Range	100% F.S.
Zero Range	4% F.S.
Stable Time	≤10sec
Overload	100% F.S. + 9e
Safety Load	150% F.S.
Ultimate Load	400% F.S.
Battery	6V/4.0Ah lead acid rechargeable battery.
Charger	100~220VAC 50/60Hz input 7.2VDC/1000mA output
Display	35mm (1.4inch) LED module
Op. Temp.	-10°C ~ +40°C
Op. Humidity	20°C ≤90%

4. Capacity

Modal	Max. Cap.	Min. Cap.	Res.	Division
OCS-1-T	1,000kg	10kg	0.5kg	2,000
OCS-2-T	2,000kg	20kg	1kg	2,000
OCS-3-T	3,000kg	20kg	1kg	3,000
OCS-5-T	5,000kg	40kg	2kg	2,500



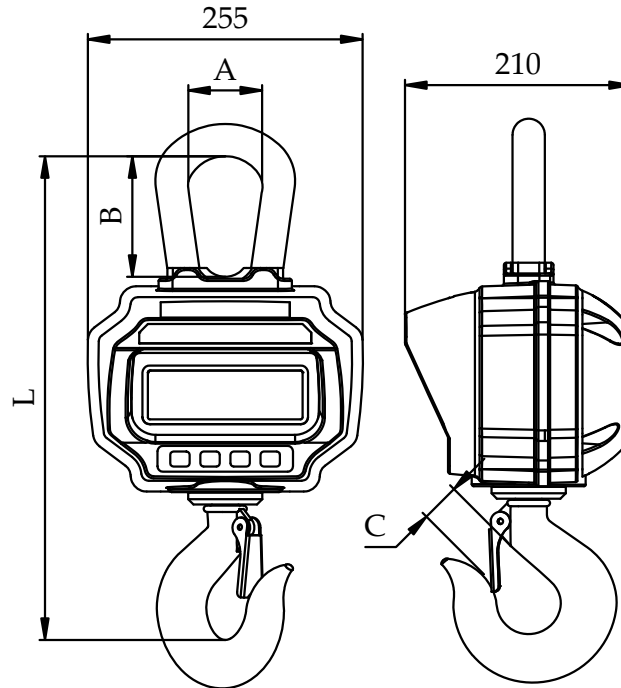

5. Dimension & Weight









Modal	A	B	C	L	N.W.
OCS-1-T	68mm	112mm	40mm	420mm	11.0kg
OCS-2-T	68mm	112mm	40mm	420mm	11.0kg
OCS-3-T	68mm	112mm	40mm	420mm	11.0kg
OCS-5-T	68mm	112mm	45mm	450mm	12.5kg





6. Display & Keys

Scale Keys

Key	Name	Function
	On/Off	Press 1s to power on/off scale. Return to weighing mode.
	Zero	Manual Zero. Increase flashing digit.
	Tare	Tare in/out. Right scroll flashing digit.
	Hold	Lock/unlock reading. Confirm.

Remote Keys

Key	Name	Function
	Zero	Same as  .
	Tare	Same as  .
	Hold	Same as  .
	Acc.	Accumulate weight. Decrease flashing digit.

	Del.	Delete last weight. Clear all weight. Left scroll flashing digit.
	F1	View. Input decimal point.
	F2	Unit switch.
	Off	Press 1s to power off. Return to weighing mode.
	2nd	2nd function.

Indicators

LED	Name	Note
STB.	Stable	lit when weight is stable
ZERO	Zero	lit when weight is at zero
TARE	Tared	lit when scale is tared
HOLD	Hold	lit when scale is locked
lb	lb	lit when unit is lb
kg	kg	lit when unit is kg





Message

Message	Stand for	Note
-----		detect weight
?		in Idle Mode
Setup	SETUP	User Setup Menu
Bat??	BATtery	battery life percentage
P0000	Password	in Password Mode
end	END	save and exit
off	OFF	power off





over	OVERload	overloading
2nd	2ND	2nd function
err	ERRor	invalid operation
acc	ACCumulate	accumulate weight
del	DELeTe	delete last weight
Clr	CLear	delete all weight

7. Operations

Power On/Off

- Press  for 1s to power-on scale. Scale perform initialization and power-on test, ***** shows twice, then capacity |5000 shows, battery life percentage bat90 shows, weight detection ----- shows and then auto zero.
-  For information about Auto-Zero, refer to Scale Configuration in Technical Manual.
- Press  or  for 1s to power-off scale. Battery life percentage bat90 shows, off message |off| shows, and then cut off power.

Zero



- Press  or  to zero. **ZERO** light on.
-  If load is in motion, or tared, or out of Manual-Zero Range, |err| shows.
-  For information about Manual-Zero Range, refer to Scale Configuration in Technical Manual.

Tare In/Out



- In gross mode, press  or  to tare in. **TARE** light on.



i If load is in motion, or negative, or out of Tare Range, |err| shows.

 Tare will reduce the apparent overload range of scale. For example, if a 5000*2kg scale has a 1000kg container as its tare, the scale will overload at a new weight of 4018kg (5000 – 1000 + additional 9 divisions).

In net mode, press  or  to tare out. **TARE** light off.

Lock/unlock

Press  or  to lock screen. **HOLD** light on.

Press  or  to unlock screen. **HOLD** light off.

Accumulate

Press  to accumulate current weight.



 |acc| shows, indicating weight is accumulated. Scale uses displayed weight, so gross or net weight is added into the same accumulator.

i If load is in motion, or negative, or does not return to zero before, |err| shows.

View

Press  to enter View mode.

 Display flashes accumulated weight.

Press  or  to view high 5-digit or low 5-digit.

Press  or  to exit View mode.

Delete Last Weight



Press  to delete last accumulated weight.

 |del| shows, indicating last accumulated weight is deleted.



Delete function only deletes the last weight.

-  If last accumulated weight has been deleted, |err| shows.

Clear All Weight

- Press  first and then press  to clear all accumulated weight.
-  |clr| shows, indicating all weight is cleared.







Unit Switch

- Press  to switch unit in between kg, lb, and User Unit.
-  When unit is kg, **kg** LED light on. When unit is lb, **lb** LED light on. When unit is User unit, **kg** and **lb** LED all light off.
-  For more information about User Unit, refer to Scale Configuration in Technical Manual.







8. User Setup

- Press  first and then press  or  to enter User Setup menu. setup shows.









Auto-Off Timing

- Press  or  to enter Auto-Off Timing. off?? shows.
- Press  or  and  to change timing value.
-  Auto-Off Timing can be set to: 0(disabled), 5(5min), 10(10min), 15(15min), 30(30min), 60(60min). It is disabled by default.
-  Auto-Off function maximizes scale's battery life against people's carelessness not to power off scale when it's not working. Auto-Off starts countdown timer when there's no action or load is stable. Any key pressing or motion in load restarts countdown timer.

Display Brightness

- ✓ Press  or  to enter Display Brightness. `br||?` shows.
- ✓ Press  or  and  to change brightness value.
- ↪ Display Brightness can be set to: 1(dim), 2(normal), 3(bright).
-  Dim LED brightness saves battery power dramatically.

Idle Mode Timing

- ✓ Press  or  to enter Idle Mode Timing. `idl??` shows.
- ✓ Press  or  and  to change timing value.
- ↪ Idle Mode Timing can be set to: 0(disabled), 5(5sec), 10(10sec), 15(15sec), 30(30sec), 60 (60sec). It is 30sec by default.
-  To maximize battery life, scale automatically enters Idle Mode, when there's no action or the load is stable. In Idle Mode, scale works in low-power consumption status. Any key pressing or motion in load wakes up scale from Idle Mode.
- ✓ Press  or  to exit User Setup.

9. Battery Maintenance

To maximize battery life, please note the following battery maintenance guide.

- ① This scale is powered by a 6V4.0Ah rechargeable lead-acid battery.
- ① Battery is permanently fixed inside battery house.
- ① Depending on LED brightness and idle mode setting, battery works from 60 hours to 200 hours.
- ① In order to conserve battery life, enable Auto-Off and Idle Mode, dim LED brightness.
- ① Charging time for a completely discharged battery is

approximately 12 hours.

- ❗ To obtain maximum service life, battery should be stored between -20°C (-4°F) and +50°C (122°F). Stored batteries should be recharged every three months.
- ❗ During charging, green LED indicates full of power, while red indicates that charging is going on.

10. Troubleshooting

Simple problems can be resolved as below listed solution. If problems still exist, please contact your local representative.

Symptom	Possible Cause	Suggested Solution
not power-on after On/Off is pressed	discharged / defective battery	check battery and charge
	defective On/Off key	press harder and keep pressing 2s
	defective power cable	open front panel, check power cable
	defective mainboard	contact representative
display flashes	discharged battery	charge battery
no action taken after key pressed	scale is disturbed	re-plug power cable
	defective key	contact representative
weight reading not stable	load in motion	keep load stable
	weak Anti-Motion	change Anti-Motion level
	damped loadcell or	dry loadcell or

	mainboard	mainboard
	defective mainboard	contact representative
weight reading not zero when no load	discharged battery	charge battery
	load-cell stressed too long	hang scale in storage
	discharged battery	charge battery
large error in weight reading	scale not zeroed before applying load	manual Zero scale before loading
	wrong unit	switch to correct unit
	scale requires calibration	calibrate scale
	defective loadcell or mainboard	contact representative
battery can not be recharged	defective charge board	contact representative
	defective battery	contact representative
short remote controlling distance	discharged / defective remote battery	replace remote controller batteries

11. Loading Procedures

DO NOT attach oversized interface!

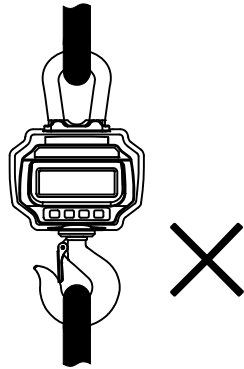

DO NOT push/pull on loaded scale or directly on hook!

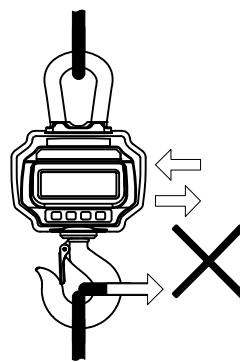

DO NOT use multiple attachments!

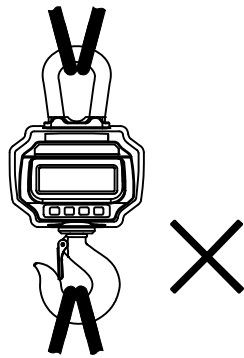

Use hardware that creates single point attachments.

