

ANYLOAD[®]

110ES-WL-HP

Wireless Tension Link Crane Scale
Operations Manual (v1706)



Anyload Transducer Co. Ltd

Website: www.anyload.com

Email: info@anyload.com

TABLE OF CONTENTS

1. Safe Operation Guides	2
2. Technical Data	3
2.1 110ES-WL-HP Crane Scale Outline	3
2.2 805HP-WL Indicator Diagram	4
3. Preparation	4
3.1 Crane Scale Battery Installation	4
3.2 Indicator Battery Installation	5
4. Start up and Communication	5
4.1 The Scale Body	5
4.2 Indicator	6
4.3 Communication	6
5. 805HP-WL Indicator	6
5.1 Display Icon List	6
5.2 Key List	7
6. Cleaning	9
7. Disposal	9
8. Troubleshooting	9
8.1 Crane Scale Troubleshooting Guides	9
8.2 Indicator Troubleshooting Guides	13

1. Safe Operation Guides



Operator should read these instructions carefully and observe them in operating the scale:

- ✓ Strictly prohibited of hanging loads that surpass the maximum capacity of the crane scale. The loads should not also surpass the maximum rated loads of the shackles, wire ropes, round-link chains and hooks.
- ✓ When shackles, wire ropes, round-link chains or hooks have signs of defects or worn out due to excessive work, the scale should not be operated.
- ✓ Before moving the crane scale, make sure the shackles, wire ropes, round-link chains and hooks, etc are in the center of the crane hook, and insurance deduction is closed.
- ✓ Make sure the crane operator is in safe working position prior in hanging loads to the crane scale. At the same time, it is recommended that the load suspension height is not too high to minimize any accidents. When the crane scale is hanged with loads, the operator should keep the main switch or button in the operating state.
- ✓ When hanging weights to the crane scale, the crane operator and rigger should ensure the hanged loads are secured and safe. Making sure no objects that are loosen or may fall off to the ground.
- ✓ Remove all the wire ropes, round-link chains, cables, shackles and other hanging components when the scale is not in use.
- ✓ Strictly prohibited of loading the scale to pass over a person or an equipment.
- ✓ When lifting and transporting, lift the loads gently to prevent the scale from shocking.
- ✓ Crane scale is a lift equipment, so it should be maintained and checked regularly.
- ✓ Do not remove any parts of the scale. Do not knock or drop the scale or indicator.
- ✓ Please use a soft cloth and a small amount of water with detergent to clean the scale's body and enclosure and indicator's housing. Do not use benzene, nitro

solvents, caustic soda liquid and other corrosive substances for cleaning.

- ✓ The additional tare weight added under the scale must not exceed 15% of the scale.
- ✓ Before installing the crane scale, please pre-link with the instruments to check whether the scale's body and the instrument can work normally. Check whether the battery power is enough to use for the operation.
- ✓ Hanging scale installation location should be as close as possible to the small swing amplitude and small vibration position. In this way, the scale can provide better weighing accuracy and may extend the service life.
- ✓ When the equipment displays the overload warning, stop loading weights immediately and gradually remove the weights.
- ✓ Always lift loads vertically.

Failure to observe those safe operation guides may result in serious injury or even fatality.

2. Technical Data

2.1 110ES-WL-HP Crane Scale Outline

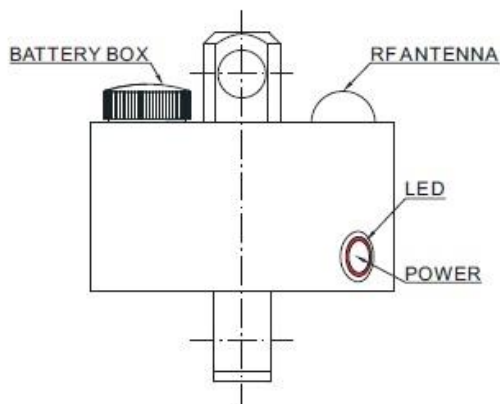

2.2 805HP-WL Indicator Diagram

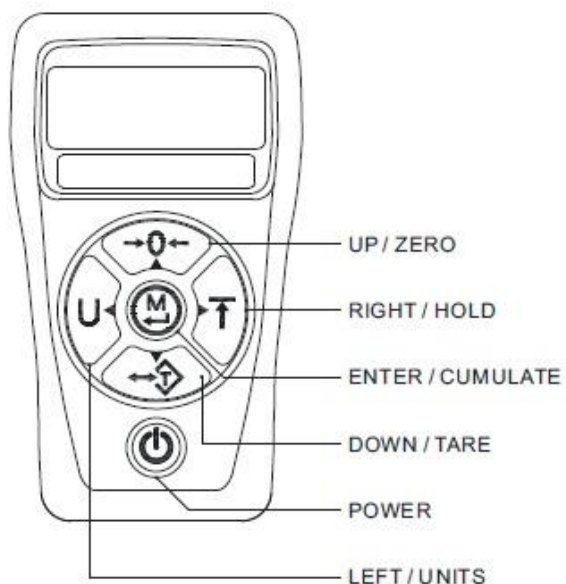

3. Preparation

3.1 Crane Scale Battery Installation

- Unscrew the battery compartment cover (counter clockwise) and pull out the battery holder assembly.

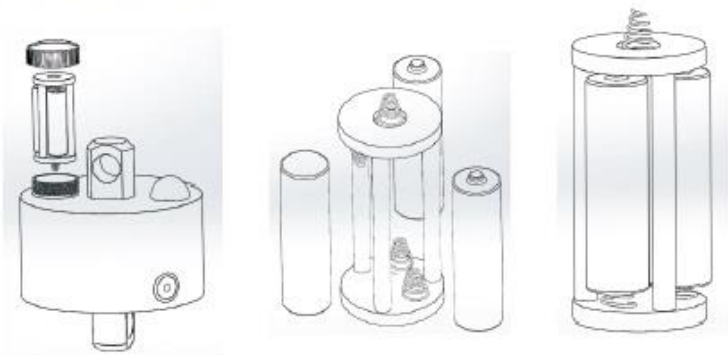

- Install the batteries into the battery holder, and check the polarities of the battery are inserted to the correct polarity.
- Install back the battery holder into the crane scale and tighten the cover of battery compartment to complete the installation.

3.2 Indicator Battery Installation

- Remove the screws at the back of the indicator and remove the battery compartment cover.
- Install the batteries into the battery compartment and check the polarities of the battery are inserted to the correct polarity (positive and negative). Close the battery compartment and tighten it.

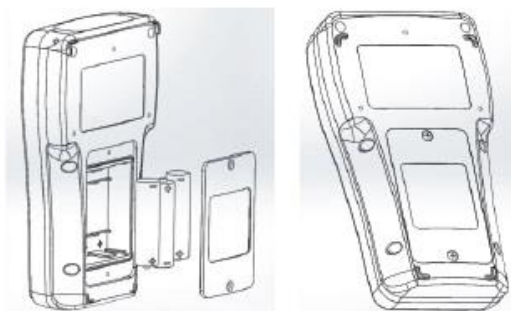

4. Start up and Communication

4.1 The scale body

Start up: After installing the batteries, long press the power button for 2 to 3 seconds. Red LED should light up then release the power button.

Standby: When no signals are detected from the indicator upon switching it on, the scale will go to standby mode. In this case, press the power button again and red LED should light up.

Power off: From active or standby mode, long press the power button for 3 to 5 seconds. The scale will be turned off.

4.2 Indicator

Start up: After installing the battery, long press the on/off button for 2-3 seconds then release it. The indicator will beep and the screen shows initialization until reached to indicator weighing system.

Power off: Long press on/off button for 2-3 seconds then release it. The screen shows OFF, the indicator is turning off.









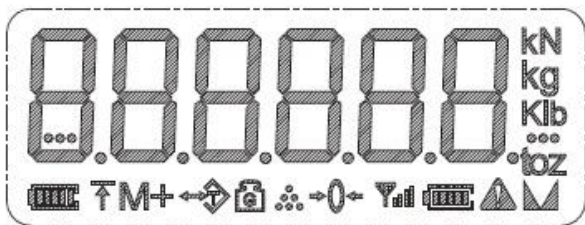



4.3 Communication

There is no particular order in starting up the scale or the indicator. Both devices will collect signals from each other and should communicate. When the LED light of the scale is flashing and the wireless communication sign  appears in the 805HP-WL indicator, both devices have established communication.

5. 805HP-WL Indicator







5.1 Display Icon List



Icon	Meaning
	805HP Battery Power indicator
	Peak hold mode
	Weights saved to memory
	Tare value acquired
	Gross weight mode
	Cumulate Mode
	Scale is zeroed
	Wireless signal strength
	Load cell battery power indicator (dotted line)
	Weight exceeded the maximum capacity "overload warning value" signal
	Signal stability
	There are hidden figures which can be shown on the following page

5.2 Key List



Buttons	Press Time	MODE			MENU	
		Normal Mode	Peak Mode	Cumulate Mode	Menu Selection	Parameter Adjustment
	Long Press (2S)	Power Off	Power Off	Power Off		
	Short Press (0.5S)					
	Long Press (2S)	Gross weight/ Net weight		Gross weight/ Net weight		
	Short Press (0.5S)	Tare/ Untare			Enter in this menu	Reduce the parameter
	Long Press (2S)					
	Short Press (0.5S)	Units switch	Units switch		Switch menu to the left	Adjust the digit to the left
	Long Press (2S)			Clear cumulative value		
	Short Press (0.5S)	Zero scale			Exit in the menu	Increasing the parameter
	Long Press (2S)	Go to Peak mode	Return to Normal mode			
	Short Press (0.5S)	Holding/ Cancel	Clear peak value		Switch menu to the right	Adjust the digit to the right
	Long Press (2S)	Show cumulative value	Show cumulative value	Exit cumulative value		
	Short Press (0.5S)	Accumulate				Start / end adjustment

6. Cleaning

- When cleaning the equipment, remove the batteries and close the battery compartment with its cover to prevent moisture or liquids that may enter the device.
- Clean the surface of the device with a clean cloth. You may apply small amount of water or mild detergent in a damp cloth.
- Do not apply acidic, alkaline or other corrosive cleaning agents.
- The residual detergent must be wiped with a damp cloth. Upon using damp cloth, the surface of the device must be wiped with dry cloth.
- Do not use mechanical elements such as sand paper or sharp tools to remove surface dirt.

7. Disposal

- This device can't be disposed as a waste product. Dispose the product in a location where specifically designated for use as waste electrical and electronic equipment, in accordance with the existing local regulations.
- If you have any questions, please contact the responsible authority or your dealer. Once this device needs to be transferred to other units, please also include the contents of this regulation.
- Battery disposal: Batteries contain heavy metals so they shall not be thrown away freely. Please send it to the professional recycling agencies for processing.

8. Troubleshooting

8.1 Crane Scale Troubleshooting Guides

Common issue: Cannot establish into the wireless system

1. There is an obstruction between the indicator and the scale, or the distance between the scale and the indicator is too far.

【Phenomenon】

The scale turns on normally and its LED light doesn't blink. The indicator shows: "no RF" or "Y" of the indicator will not show up.

【Judgment】

Remove or bypass the obstruction or shorten the distance between the indicator and the scale body, the equipment should work normally.

【Solution】

Adjust the wireless gain to meet the farther signal connection requirements. Shorten the distance between the scale and indicator or remove any obstructions between the devices (refer to indicator's manual to adjust wireless gain).

2. The wireless address code in the indicator did not match for the scale.

【Phenomenon】

The scale turns on normally and its LED light doesn't blink.
The indicator shows: "no RF" or "Y" of the indicator will not show up.

【Judgment】

Go to the parameter settings of your indicator and check whether the pairing code is the same code with the scale (refer to indicator's manual).

【Solution】

Adjust the indicator's pairing code to match with the pairing code of the scale. Turn on again the scale to initialize and search the available indicator. Refer to indicator's manual in setting wireless communication.

3. Wrong Operation lead to calibration failure

【Phenomenon】

The scale turns on normally, LED light blinks, and the indicator reading is very large or not stable or the indicator can't show and the reading "-----" (six bars).

【Judgment】

The scale and the indicator are turned on and entered into the indicator standard value calibration system —— “CAL”, and then enter the zero reading system —— “Zero”. Zero code should be normal (In normal condition scale load code number is about: 500000, and will be larger when giving the additional load.)

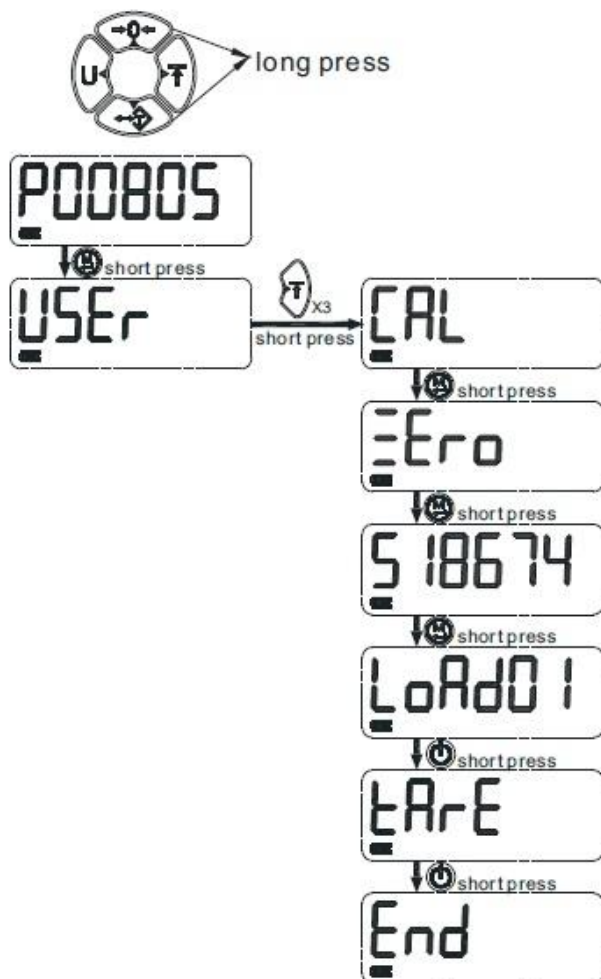

【Solution】

The indicator should be calibrated by digital input calibration. Refer to the indicator's manual in calibrating the indicator using the Digit Calibration method.

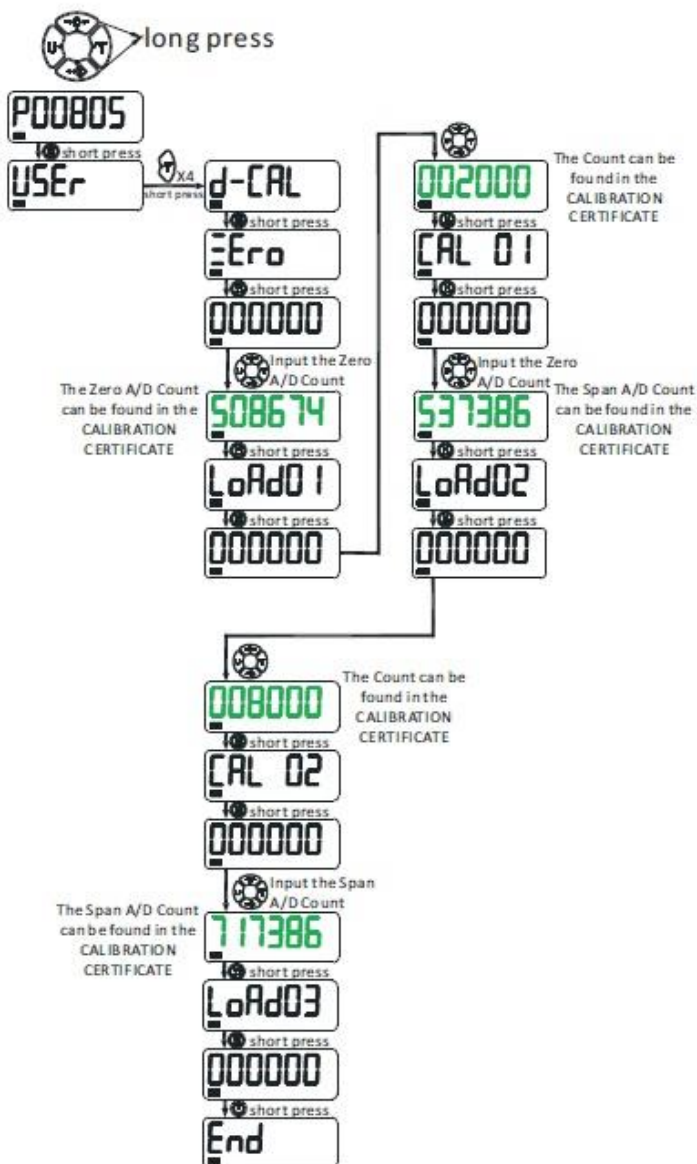

8.2 Indicator Troubleshooting Guides

PROBLEM	POSSIBLE CAUSE	SOLUTION
No display in the indicator	Defective battery / ies	Replace
	Defective button / s	Requires authorized service
	Power button not properly pressed	Press and hold ON / OFF key for three seconds
Digits flash (indicator)	Low battery	Replace batteries
Display does not respond to load changes	Faulty load cell	Requires authorized service
	Out of calibration	Re-calibration
Displayed weight shows large error	Scale is not Zeroed before applying weight	Press ZERO before applying weight
	Requires recalibration	See calibration
	Units (kg / lb) wrong selection	See operations manual
Wireless distance shortened	Wireless indicator's battery is low	Replace batteries
	Adjust the RF Power output in the indicator	See Indicator user's manual

Please refer to 805HP Handheld Digital Weight Indicator User's Manual for details in recalibration and indicator's operation guides.

Anyload Transducer Co. Ltd

Website: www.anyload.com

Email: info@anyload.com

Fax: +1 866 612 9088

North America Toll Free: 1-855-ANYLOAD (269 5623)